

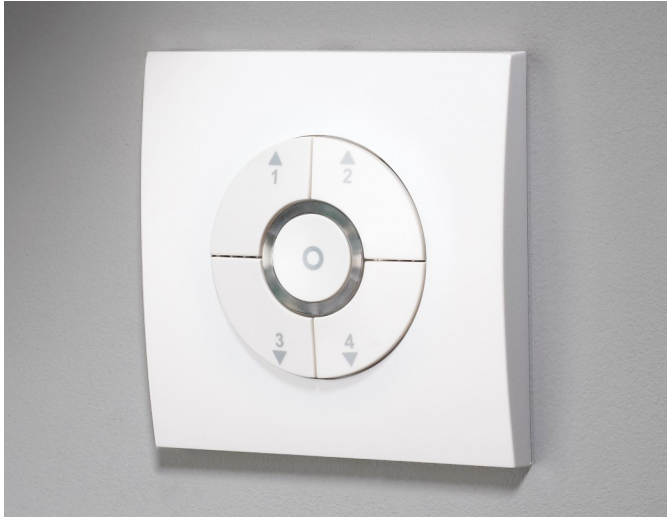

GI1DC-DD Product Guide

Single gang DALI / DSI dimmer switch

Overview



The GI1DC-DD is a single channel controller for DALI or DSI devices. The product has the following controls.

Scene buttons

Four buttons that offer 4 lighting levels. The default levels are:

- 1 - 100% brightness
- 2 - 75% brightness
- 3 - 50% brightness
- 4 - 25% brightness

These levels can be easily changed, see below.

Raise and lower function

Use either buttons 1 and 2 to raise the light level.
Use either buttons 3 and 4 to lower the light level.

Off button

Toggle between lights off and last selected Scene.

Note: the data sent from the DALI output is in broadcast mode and is not suitable for addressed systems.

Using the dimmer switch

Turning Lights On and Off

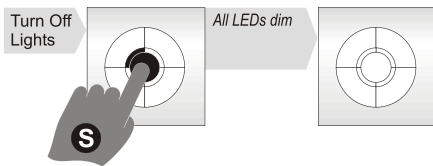
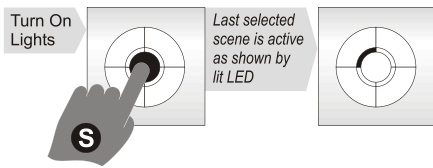

Selecting a Scene level

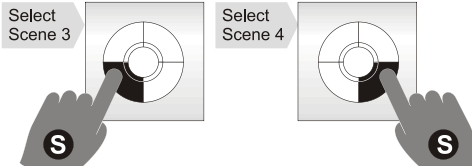
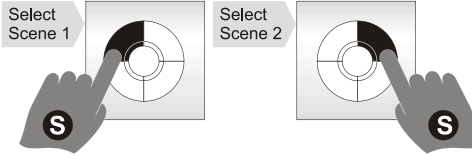

KEY

- S = Short Press
- L = Long Press (longer than 3 secs)
- H = Press and Hold

FULLY LIT or SINGLE FLASH SLOW FLASH

UNLIT / DIM FAST FLASH

Programming Scenes

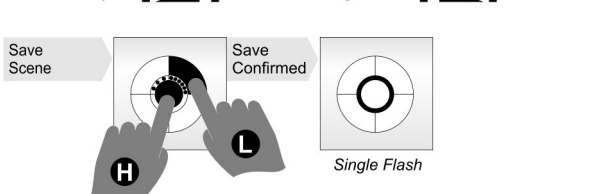
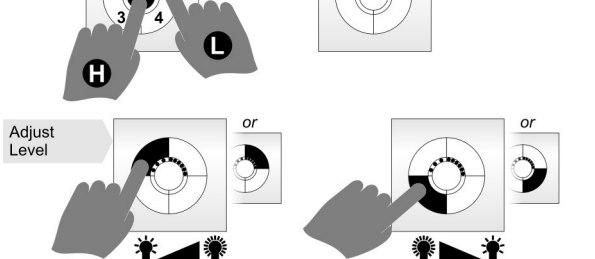
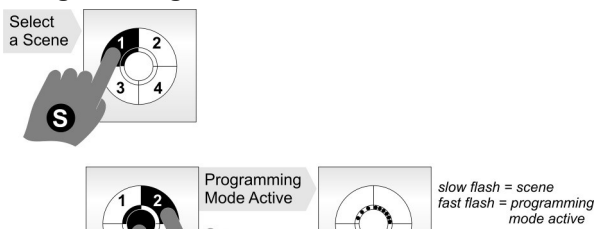

Adjusting Current Light Levels - Raise

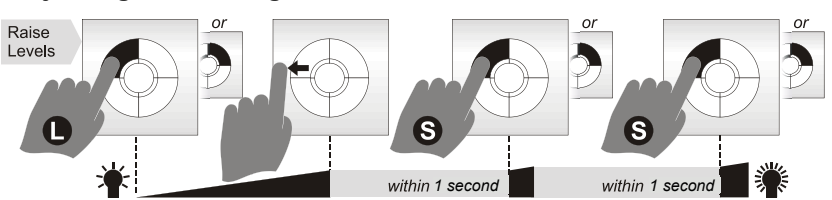

Adjusting Current Light Levels - Lower

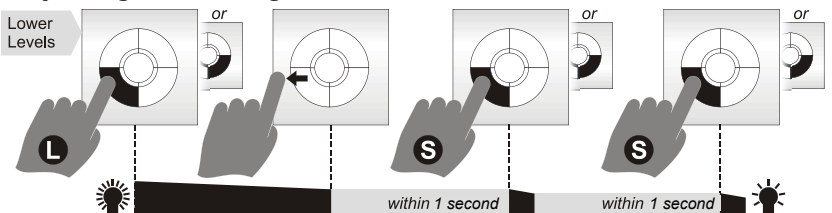

Changing from DALI to DSI Default: DALI mode

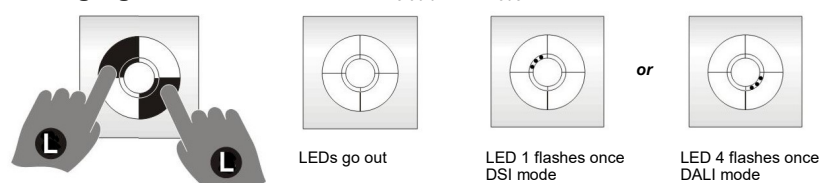

Installation

Remove front cover by using a flathead screwdriver or similar to gently prise off the cover.

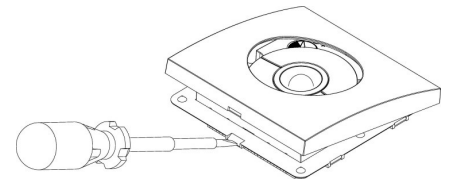

Back box Compatibility

The G11DC-DD is designed to fit both UK and EU style backboxes.

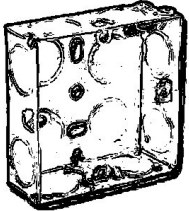

BS4662 square back box

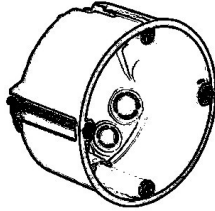

DIN standard round back box

Mounting

Use the extender if there is less than 25mm free space. *Note: put the wires through the extender before connecting.*

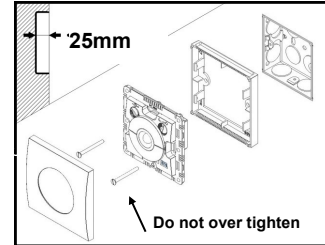

Wiring

Connect to DALI / DSI device(s)

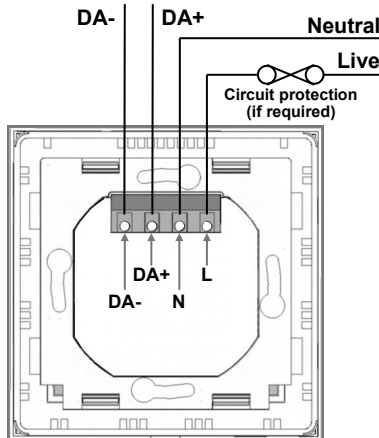

Dimensions

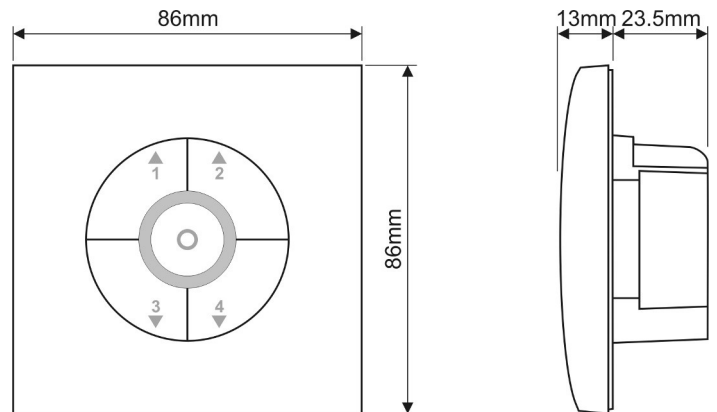

Technical data

Supply Voltage	230VAC +/- 10%
Frequency	50Hz
Power consumption	On 528mW, Off 523mW
Load	20 DALI or DSI ballasts
Weight	0.1kg
Fixing method	Surface fixing : 35mm deep plastic surface mount moulded box. Flush fixing: 25mm steel backbox or

Temperature	25mm deep cavity backbox. -10°C to 35°C
Humidity	5 to 95% non-condensing
Material (casing)	Flame retardant ABS Type Class 2
Compliance	EMC-2014/30/EU LVD-2014/35/EU
For further compliance information visit www.cpelectronics.co.uk/compliance	



Part numbers

	Part number	Description
Dimmer switch	G11DC-DD	Single gang DALI / DSI dimmer switch - white
Accessories	GIFP-ST	GI fascia Silver
	GIFP-BZ	GI fascia Bronze
	UHS7	IR user handset

IMPORTANT NOTICE!

This device should be installed by a qualified electrician in accordance with the latest edition of the IEE Wiring Regulations and any applicable Building Regulations.



C.P. Electronics Ltd
Brent Crescent
London
NW10 7XR
United Kingdom
Tel: + 44 (0) 333 900 0671
Fax: + 44 (0) 333 900 0674
www.green-iswitches.co.uk
enquiry@green-iswitches.co.uk